

STERILIZATION

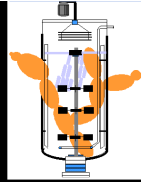

notions:

STERILITÁS -- STERILITY

ASZEPTIKUSSÁG -- ASEPTICITY

ELSZIGETELÉS, IZOLÁLÁS -- CONTAINMENT

Killing microbes

**Protecting the environment
from microbes**

**Protect the system from the microbes
aseptic operation=maintaining sterility**

**Patogenes }
Víruses } vakcinatermelés
GMO-s }

rDNS production
problems**

**OECD 1986 – Recombinant DNA
Safety Considerations
EC 1990 Council Directive on the
Contained use of GMOs**

GMO

I.: small risk

II.: others

STERILIZATION

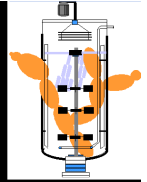

CONTAMINATION

Extra work, money

DECREASING YIELD

ALTERATION IN PROCESS BEHAVIOUR (KINETICS)

PLUS STERILIZATION NEED

WHOLE CHARGE GOES WRONG

(SCALE DEPENDENT DAMAGE)

PROBLEM AT DOWN-STREAM

STERILIZATION

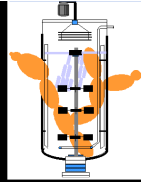

METHODS for removal and killing of microbial cells

mechanical methods: **filtration**,

centrifugation,

flotation,

electromagnetic irradiation: **UV, X** ,

chemical methods: **dezinfection**,

heat.

Thermal death of microorganisms

STERILIZATION

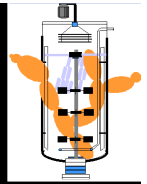

Temperature ranges of the growth of microbes

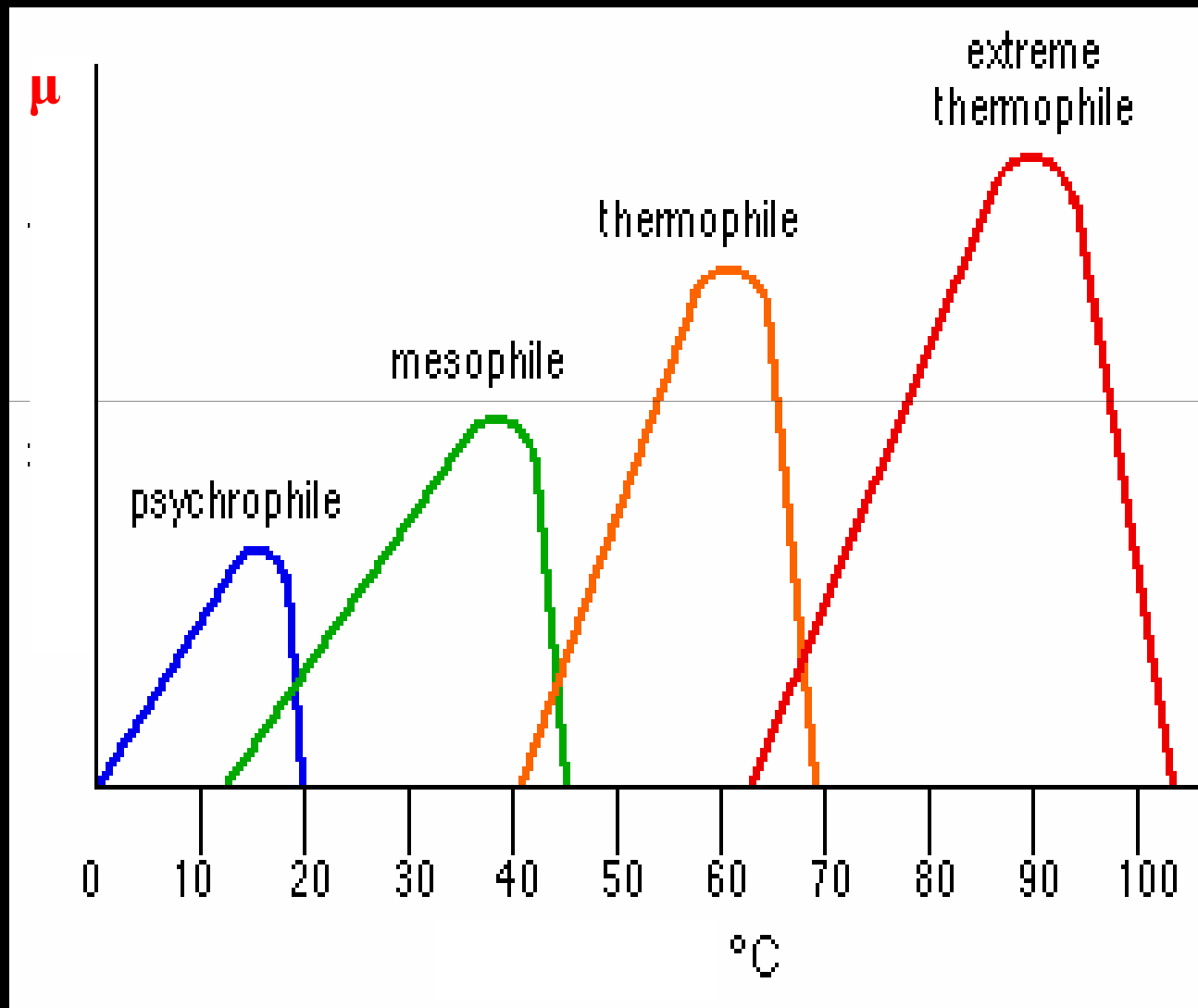

Vegetative bacterium- and yeast cells



E. coli



S. cerevisiae

Vegetative cells

Conidiospores of phylamentous fungi



P. chrysogenum
conidiospores

Viruses and bacteriophages



H1N1 influenza virus

Bacterium spores

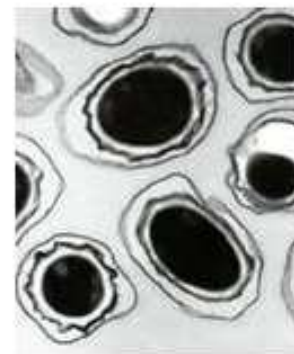

Bacillus anthracis
endospores

Relative heat resistency

1

2-10

1-5

$\sim 10^6$

STERILIZATION

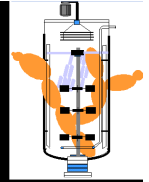

- heat sensitivity depends upon (given species): life history of the cell, age of the cell
(e.g.: cells from the exponential growth phase are more sensitive than cells from the stationary phase)
- cells are more sensitive against moist heat than against dry heat
- heat sensitivity (thermal death) increases with increasing temperature
- heat sensitivity depends on media
pH, viscosity, osmotic pressure,
presence of defending colloids,

STERILIZATION

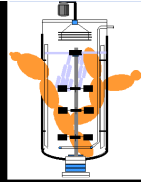

KINETICS OF THERMAL DEATH AT CONSTANT TEMP.

$$\frac{dN}{dt} = -kN$$

N number of living cells [pc/cm³]

k thermal death rate (decay) constant [min⁻¹].

$$\ln \frac{N}{N_0} = -kt$$

$$\int_{N_0}^N \frac{dN}{N} = \int_{N_0}^N d \ln N = - \int_0^t k dt \quad \rightarrow \quad \left\{ \right.$$

$$N = N_0 e^{-kt}$$

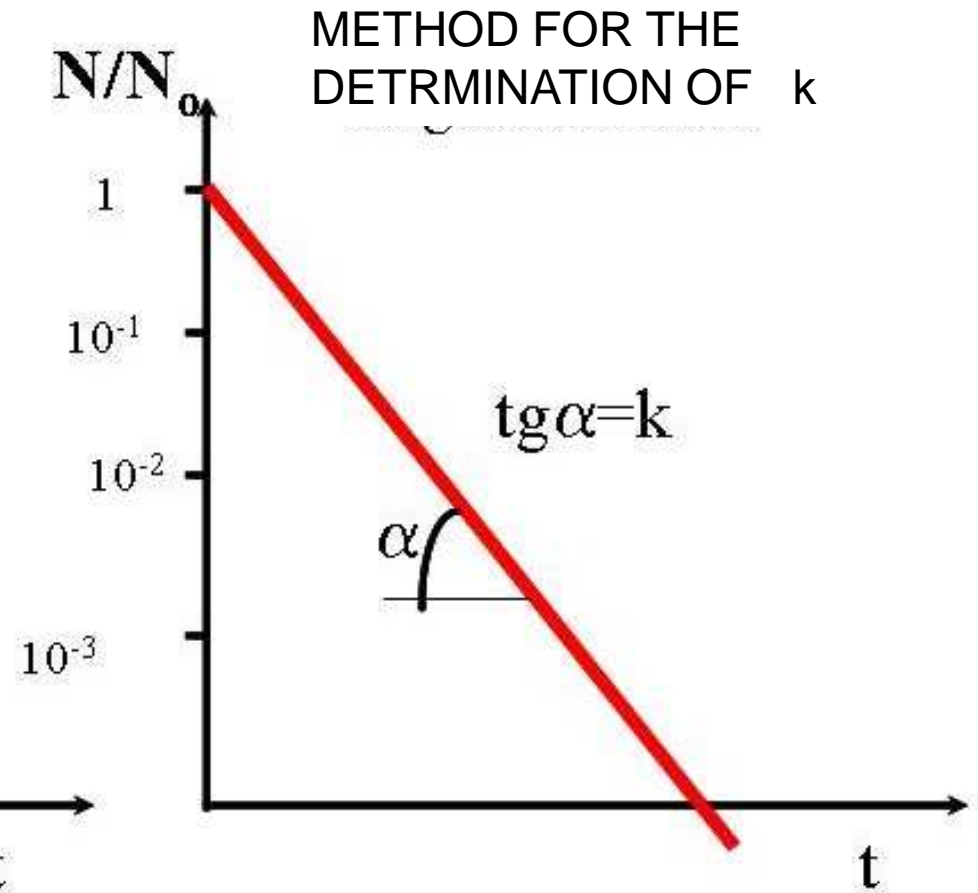
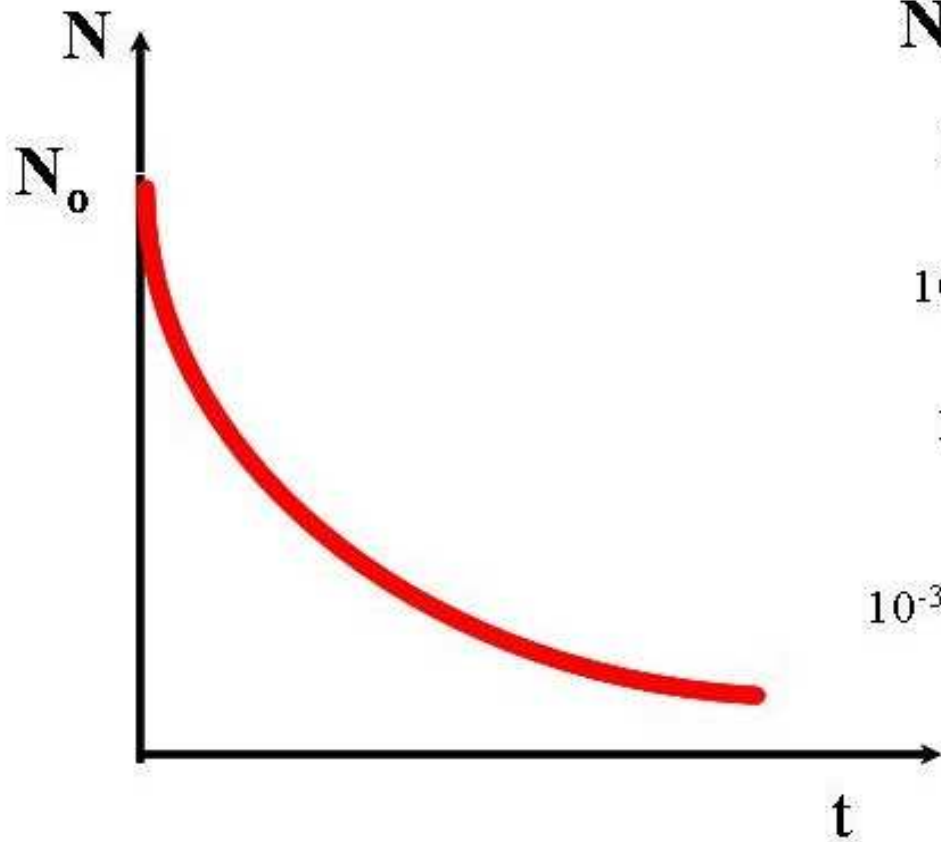

what k depends on?

microbe ...sort, „form”
medium
temperature

$$\ln k = \ln A - \frac{E_a}{R} \frac{1}{T}$$

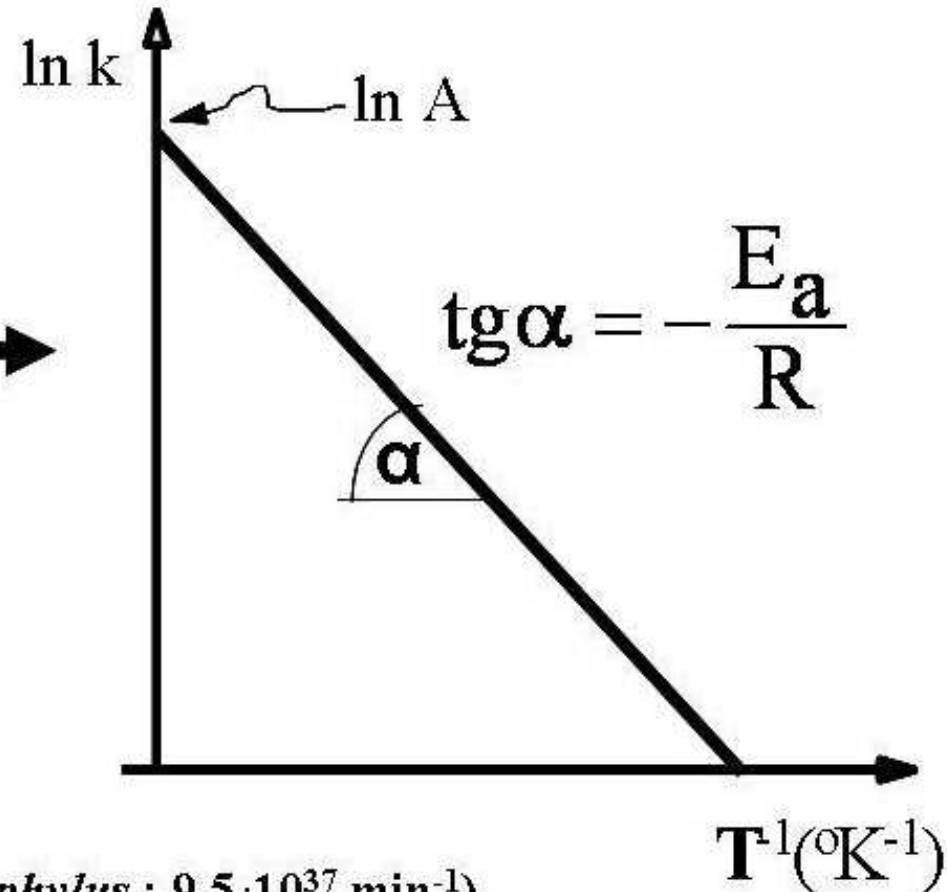

A: Empirical constant

(*Geobacillus stearothermophilus* : $9,5 \cdot 10^{37} \text{ min}^{-1}$)

E_a : Apparent activation energy of thermal death (KJ/mol)

(*Geobacillus stearothermophilus* : 70 kcal/mol) **Determination method**

STERILIZATION

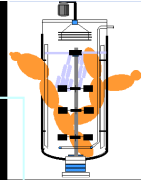

Microbe	T[°C]	k[min^{-1}]	E_a [KJ/mol]
<i>Bacillus subtilis</i> (vegetative)	110	27	310
<i>Bacillus subtilis</i> (spores)	121,1	3	-
<i>Bacillus</i> <i>stearothermophilus</i> (spores)	104 125 130	0,051 6,06 17,52	283 283 283
<i>Clostridium botulinum</i> (spores)	104	0,42	344
Hemoglobin (heatdenaturation)	68	$6,3 \cdot 10^{-3}$	312

Medium components heat decay apparent activation energies [kJ/mol]

Reaction between carbohydrates and proteins	130,6
B ₁ vitamin decay	87,9
B ₂ vitamin decay	98,8

STERILIZATION

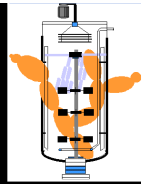

$$\frac{1}{k} = \bar{t}$$

Mean life span

$$\frac{2,3}{k} = \mathcal{D}$$

\mathcal{D}

decimal reduction time

$$\lg \frac{N_0}{N}$$

1000

100

10

1

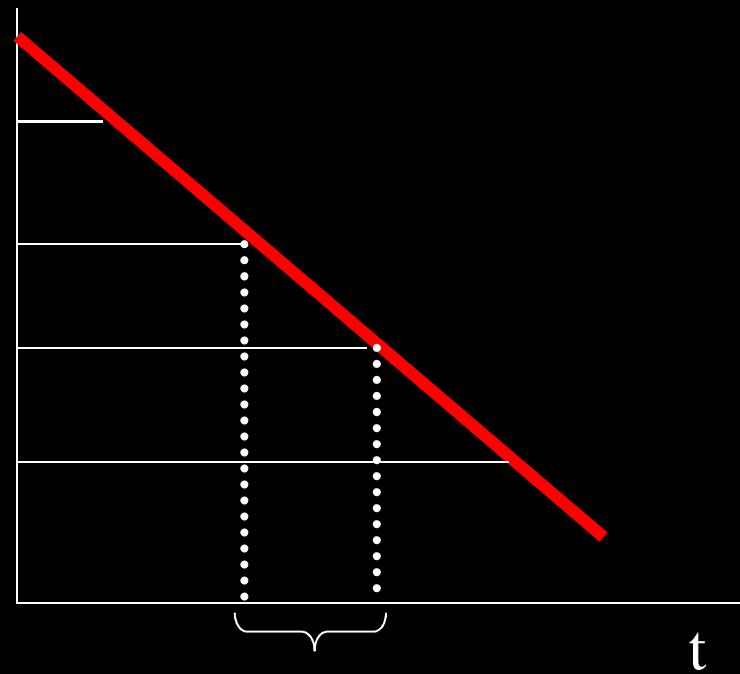

\mathcal{D}

$$\frac{1}{k} = \bar{t}$$

Mean life span

$$\frac{2,3}{k} = \mathcal{D}$$

decimal reduction time

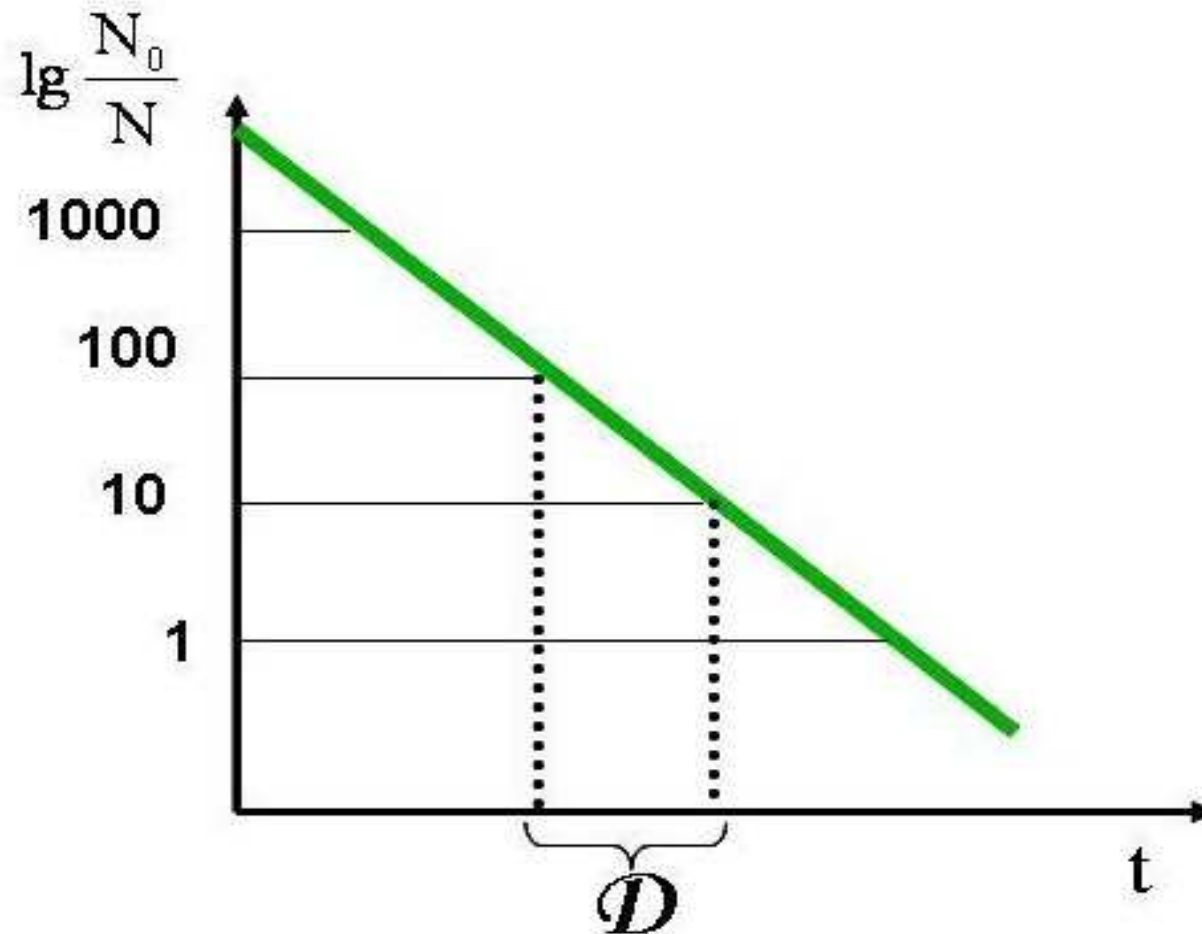

STERILIZATION

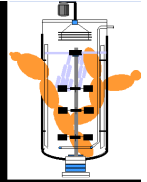

Probabilistic approach of thermal death

Kinetic description is good if $N_0 \gg 1$!

Thermal death is also a stochastic process

Definition: the life span of one cell (spore) is the length time during which the cell (spore) will just remain viable.

mean life span of the population

$$\bar{t} = \frac{1}{N_0} \sum_{i=1}^{\infty} N_i t_i$$

Life span



N_0 no of all the spores

N_i no of the spores with life span of t_i

Mean thermal decay constant

$$\frac{1}{\bar{t}} = \bar{k}$$

STERILIZATION

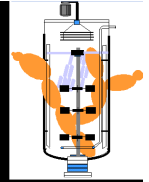

CONDITIONS

If temp is the same everywhere in the vessel,

No growth, (!!!!)

Behaviour of the individual spores is independent of the others.

Probability of the event that at time t the no of the survivors is exactly N ($N= 0,1,2,\dots,N_0$), follows a binomial distribution:

$$P_N(t) = \binom{N_0}{N} [p(t)]^N [1-p(t)]^{(N_0-N)}$$

$$p(t) = e^{-\bar{k}t}$$

probab. that one spore
is survivor at time

$$P_N(t) = \frac{N_0!}{(N_0 - N)!N!} \left(e^{-\bar{k}t} \right)^N \left(1 - e^{-\bar{k}t} \right)^{(N_0 - N)}$$

STERILIZATION

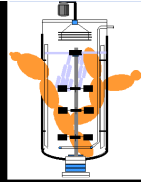

$$P_N(t) = \frac{N_0!}{(N_0 - N)!N!} \left(e^{-\bar{k}t} \right)^N \left(1 - e^{-\bar{k}t} \right)^{(N_0 - N)}$$

What is the prob. that **all** the spores had already died by the time t ?

$$P_0(t) = \left(1 - e^{-\bar{k}t} \right)^{N_0} < 1$$

Always higher than 0:

$$1 - P_0(t) = 1 - \left(1 - e^{-\bar{k}t} \right)^{N_0} > 0$$

At a common sterilization process $N_0 \gg 1$

$$1 - P_0(t) \cong 1 - e^{-N}$$

in which $N = N_0 e^{-\bar{k}t}$.

$$= 1 - e^{-N_0 e^{-\bar{k}t}} \approx N_0 e^{-\bar{k}t}$$

$e^{-x} \sim 1 - x + \dots$ according to a Taylor serie

STERILIZATION

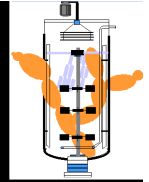

Sterility criterion? Pl .:

$$99,9\% \quad \longrightarrow \quad P_0(t)=0,999 \quad \longrightarrow \quad 1-P_0(t)=0,001=10^{-3}$$

- ★ **The probability that the sterilization had failed, i.e. there remained at least one survivor: 10^{-3}**
- ★ **The probability that the sterilization succeeded, No remaining living cells : 0,999**
- ★ **At every 1000th of sterilizations is allowed to occur one unsuccessful one. It is probable that one in thousand went wrong.**
- ★ **After the sterilization process the number of survivors (Cell in the whole system)**

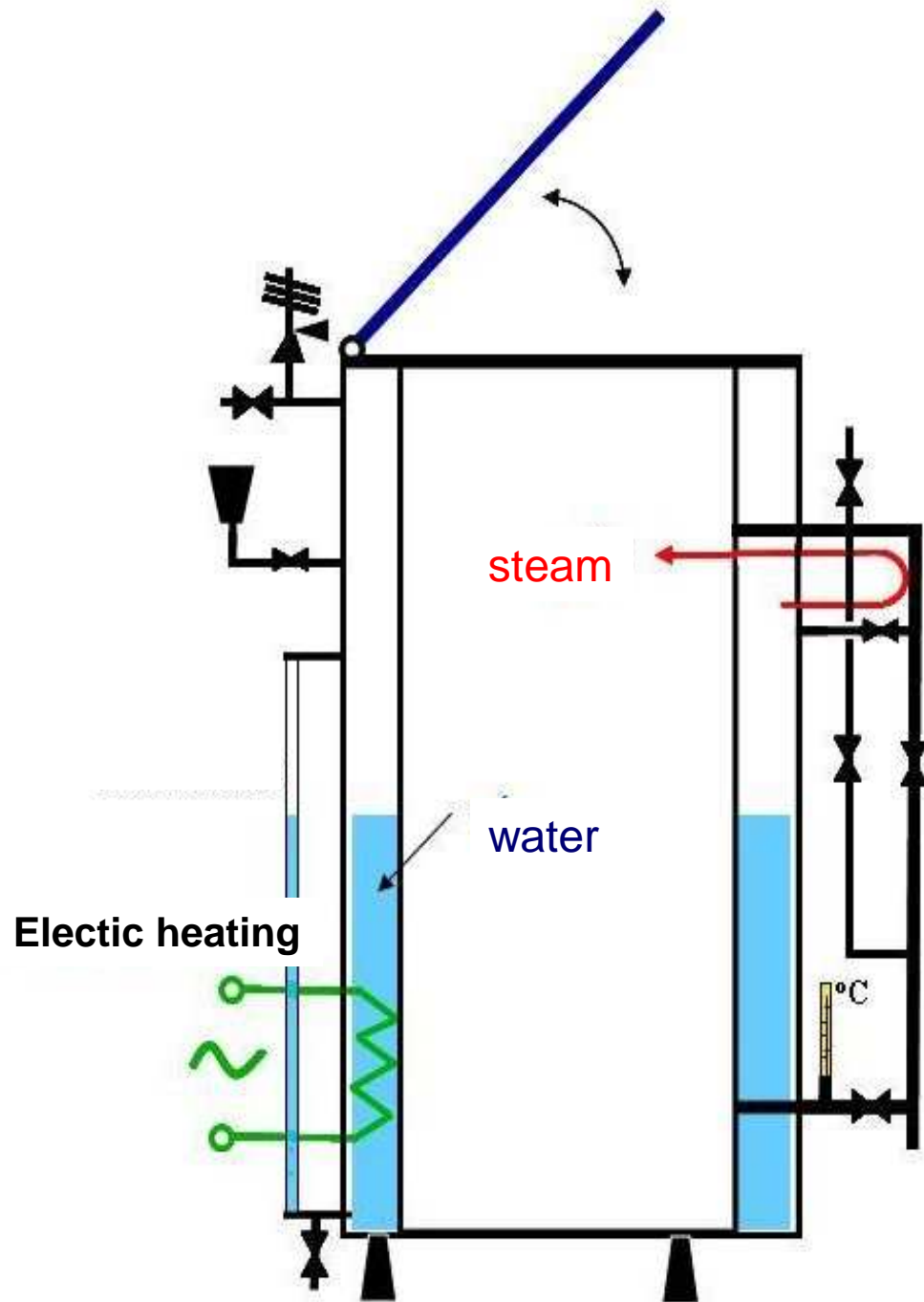

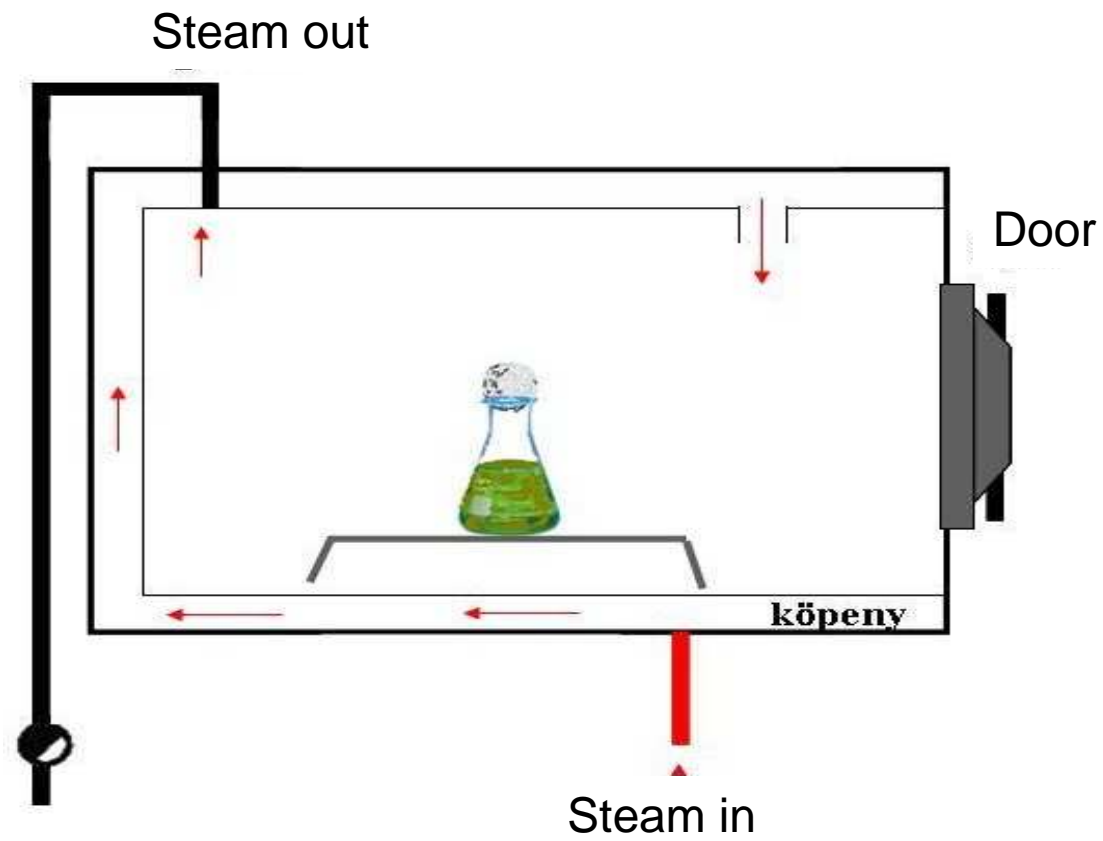

Batch sterilization of culture media

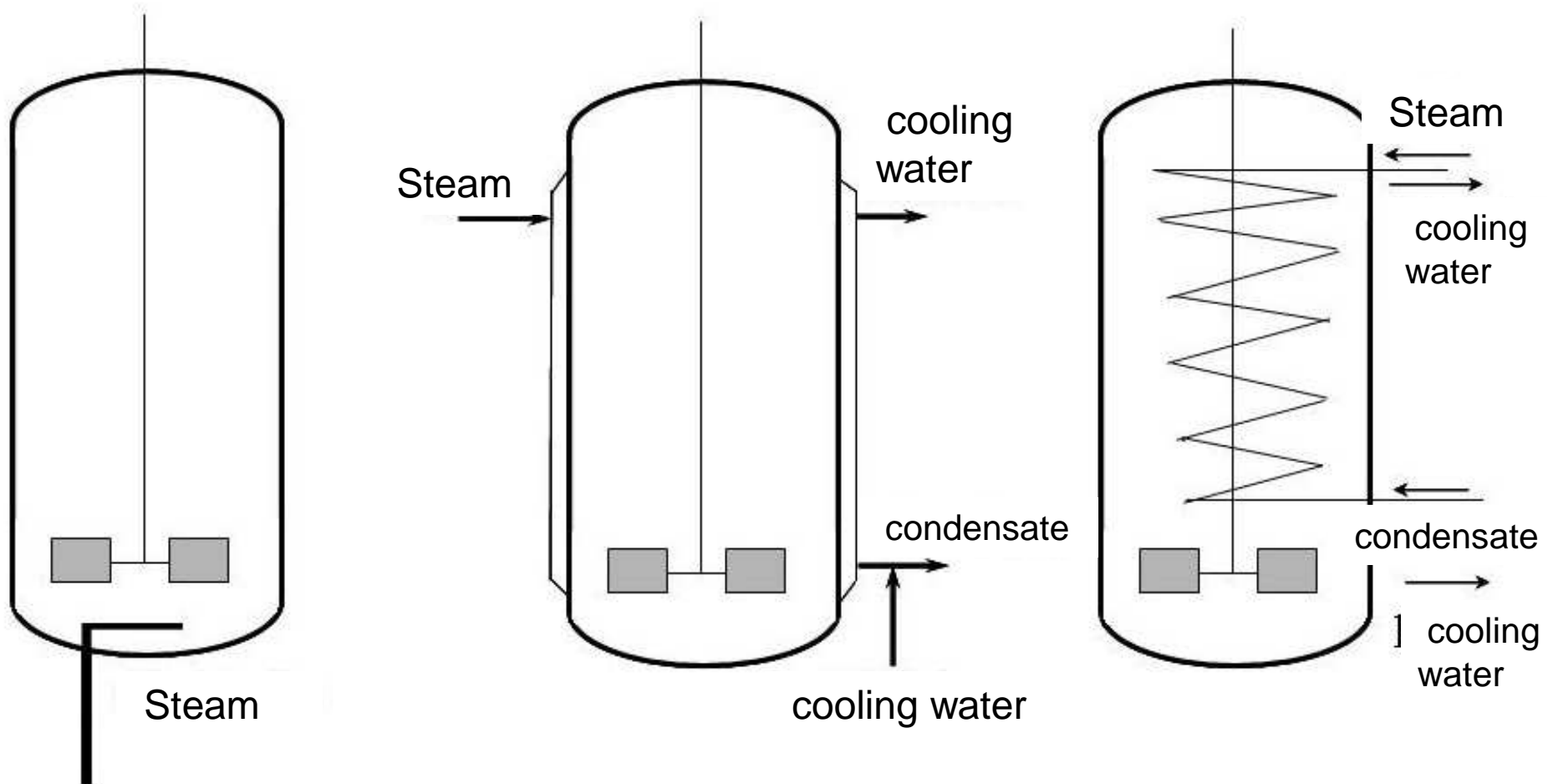

STERILIZATION

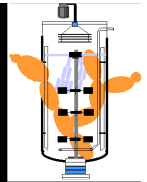

Heat penetration curve

Commeasurable sections!

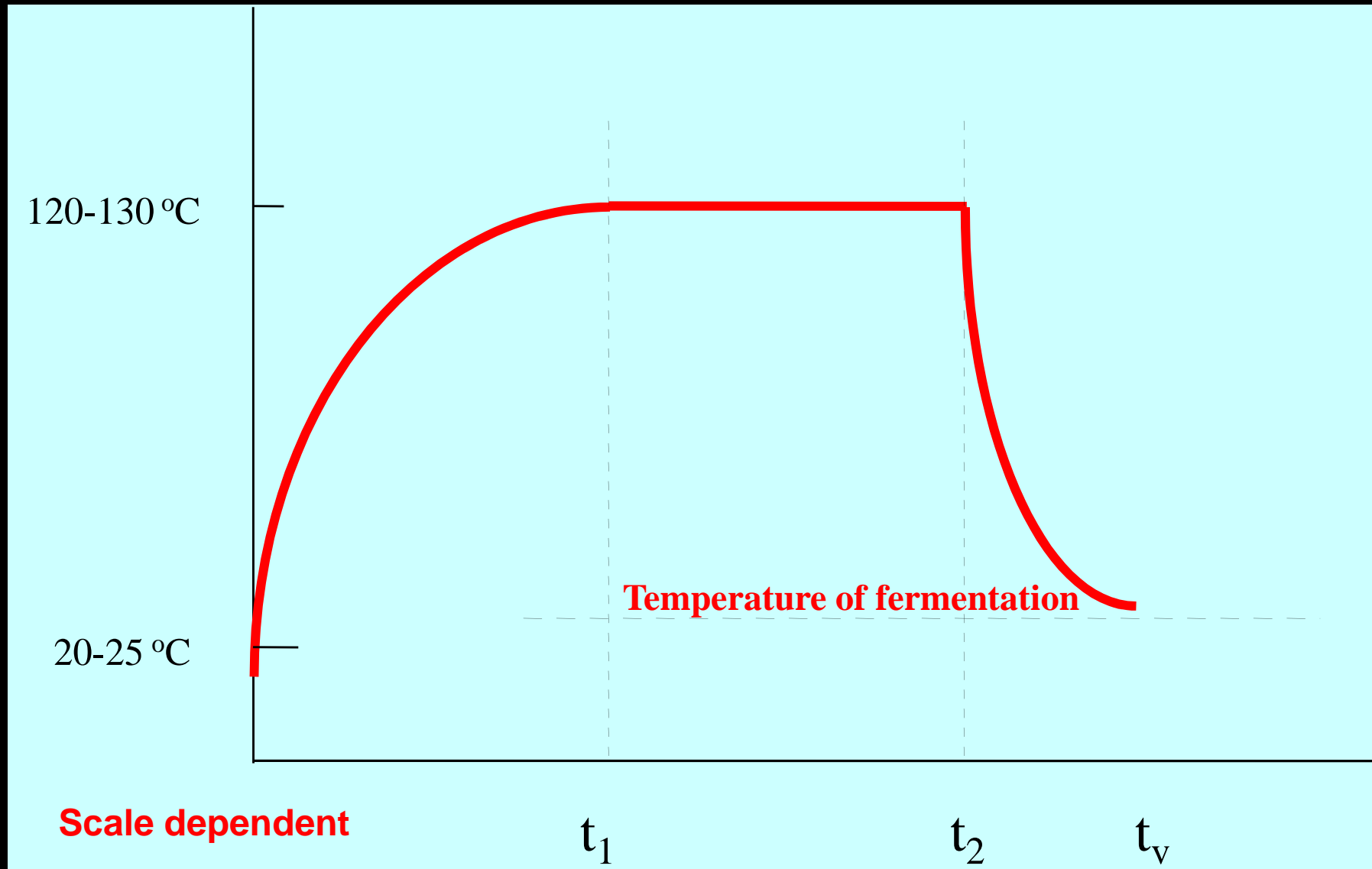

STERILIZATION

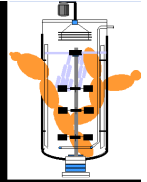

Thermal death during heating period:

$$\ln \frac{N_0}{N} = \int_0^{t_1} k dt = \nabla_{\text{heating}}$$

Thermal death during holding period:

$$\ln \frac{N_1}{N_2} = k_{\text{holding}} \cdot (t_2 - t_1) = \nabla_{\text{holding}}$$

Thermal death during cooling period:

$$\ln \frac{N_2}{N_v} = \int_{t_2}^{t_v} k dt = \nabla_{\text{cooling}}$$

$$\nabla = \nabla_{\text{heat}} + \nabla_{\text{hold}} + \nabla_{\text{cool}}$$

$$\ln \frac{N_0}{N_v} = \ln \left(\frac{N_0}{N_1} \frac{N_1}{N_2} \frac{N_2}{N_v} \right) = \ln \frac{N_0}{N_1} + \ln \frac{N_1}{N_2} + \ln \frac{N_2}{N_v}$$

e.g.: 0,20 0,75 0,05

STERILIZATION

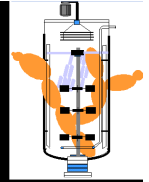

$$\nabla_{\text{factor}} = \ln \frac{N_0}{N} \quad \text{Scale sensitive!}$$

$$10^{-3}$$

$$N_0 = 10^5 / \text{ml}$$

100 liter	$\frac{10^5 \cdot 10^5}{10^{-3}} = 10^{13}$	$\nabla = 32,2$
10 m ³	$\frac{10^5 \cdot 10^4 \cdot 10^3}{10^{-3}} = 10^{15}$	$\nabla = 36,8$
100 m ³	$\frac{10^5 \cdot 10^5 \cdot 10^3}{10^{-3}} = 10^{16}$	$\nabla = 39,2$

10x: increases with 2,3

STERILIZATION

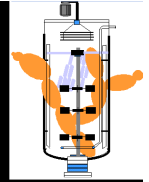

Continuous sterilization of culture media

Fermentor size limit productivity: (kg product/fermentor.m³.year).

Advantages of the cont. Sterilization process:

-at higher temp.(130-140 °C) with shorter process time

increased safety

less thermal decay of culture medium components

-the continuous process more reproducible,

-stable quality of the sterile media

this may increase the fermentation yield

**-cont. Ster. Equipment and the process easily controllable,
automation possible.**

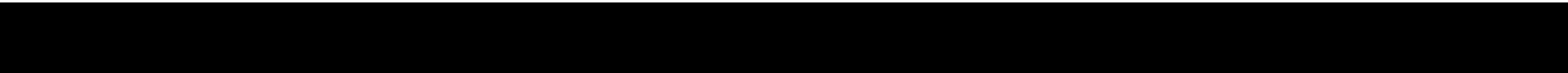

Steam injection

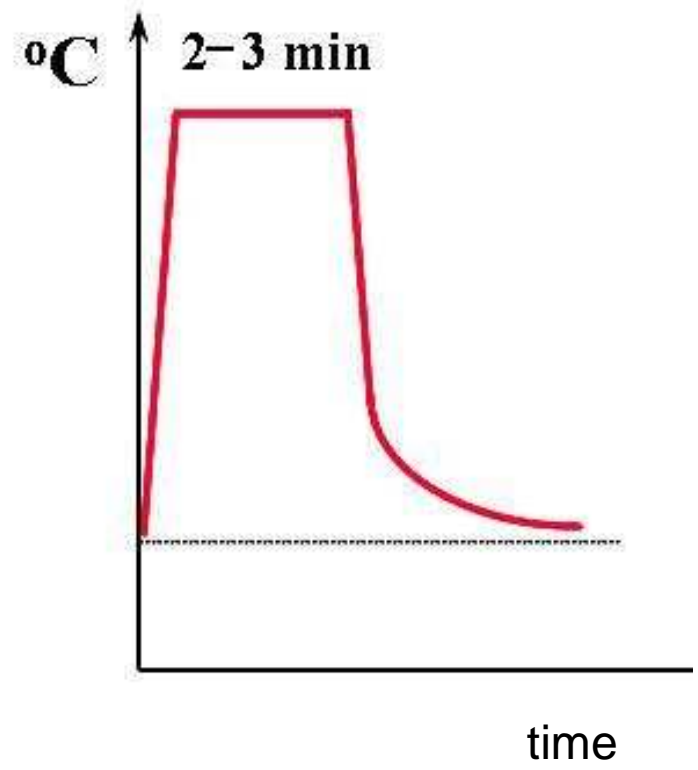
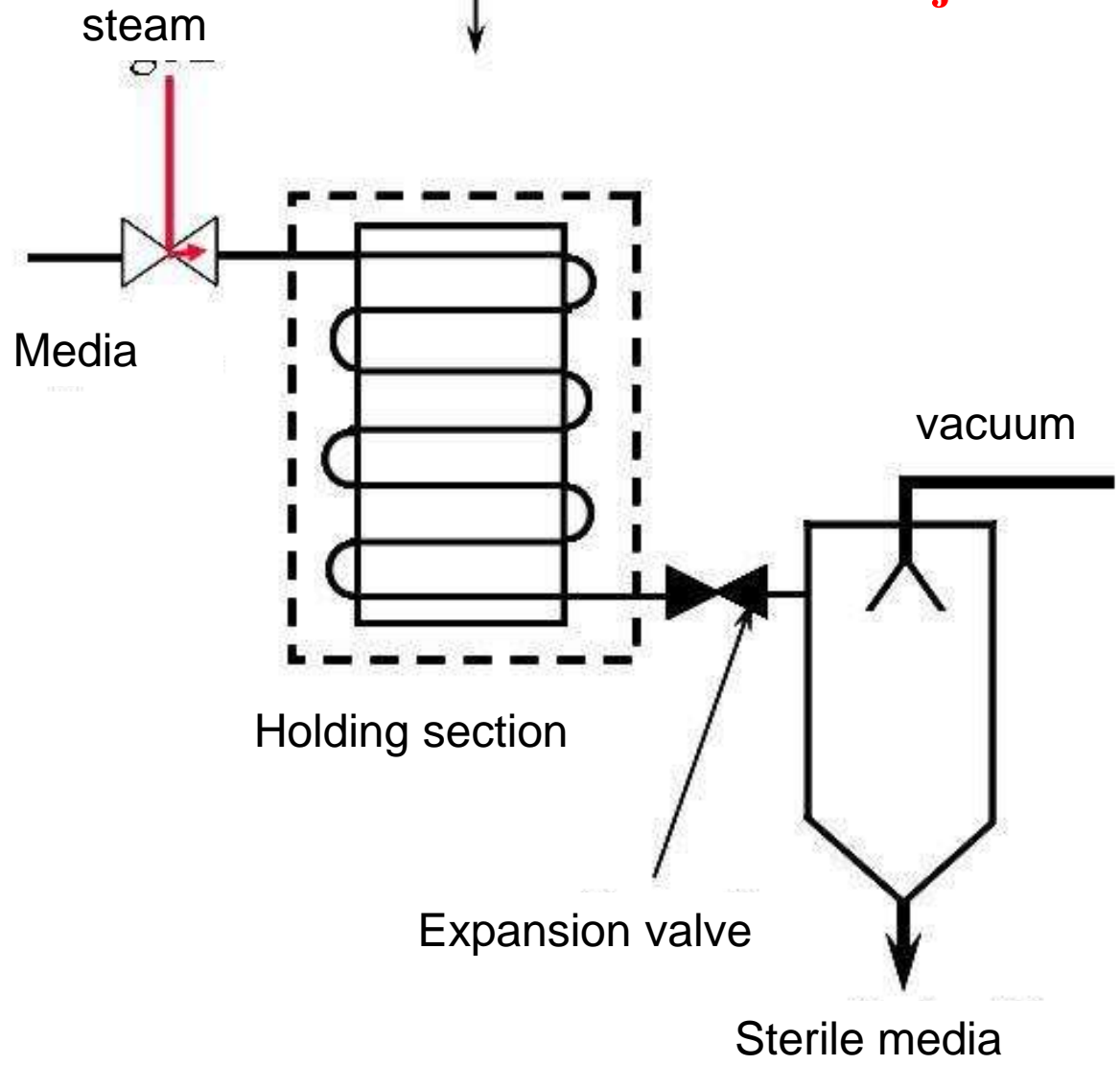

STERILEZÉS

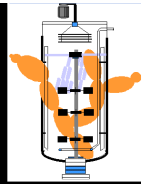
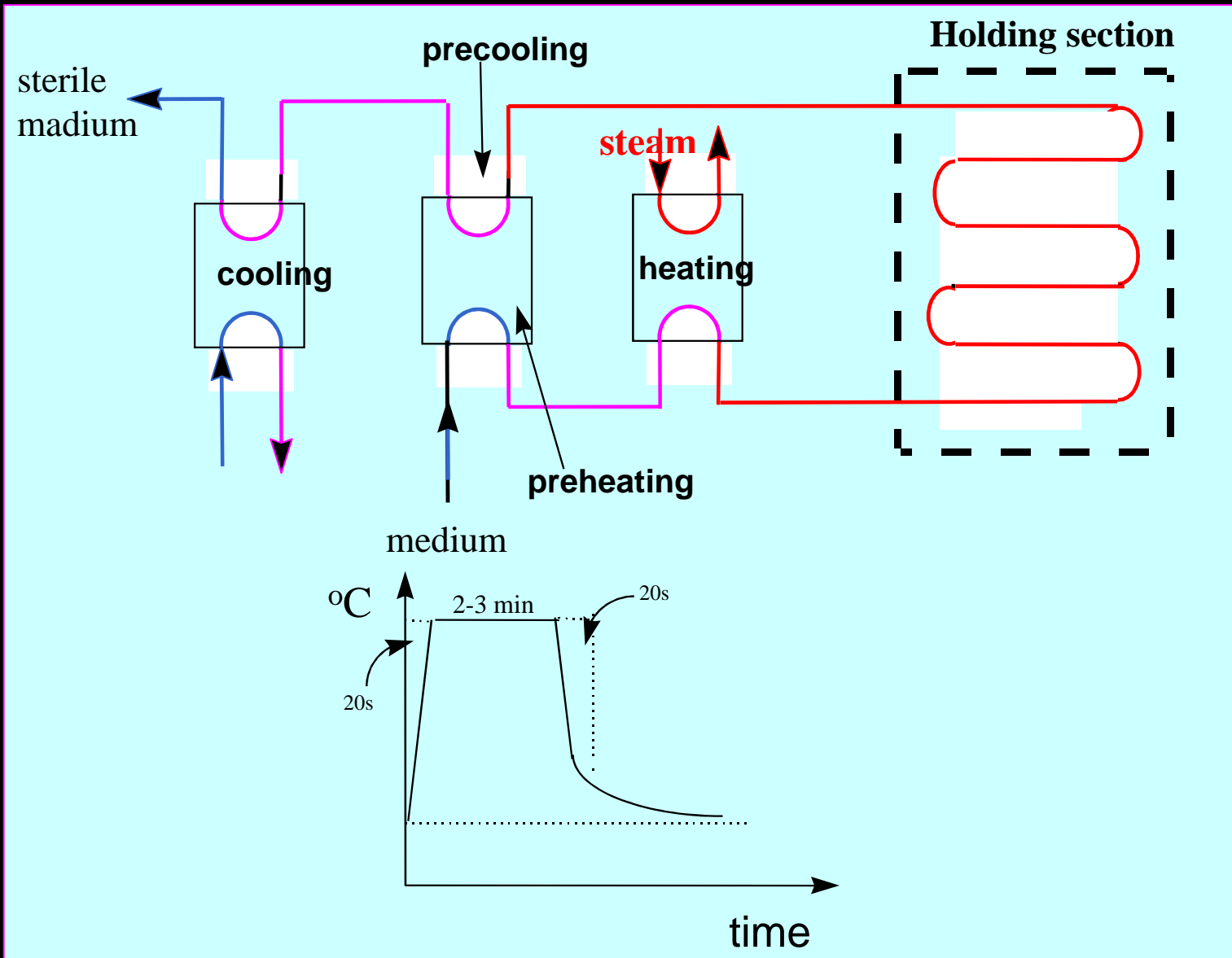
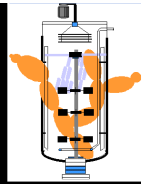

Plate and frame heat exchanger



STERILIZATION



SPIRAL HEAT EXCH.

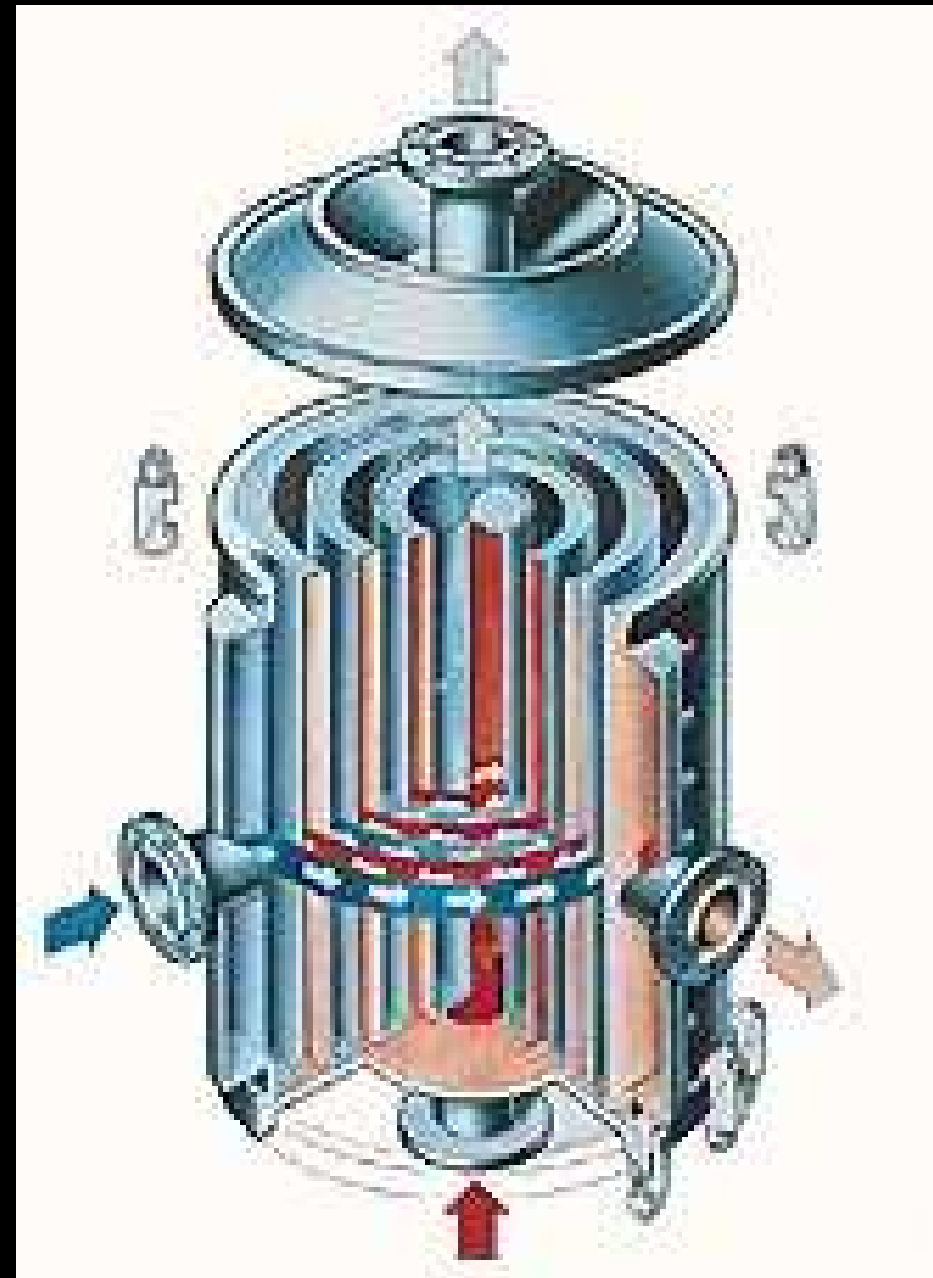

STERILIZATION

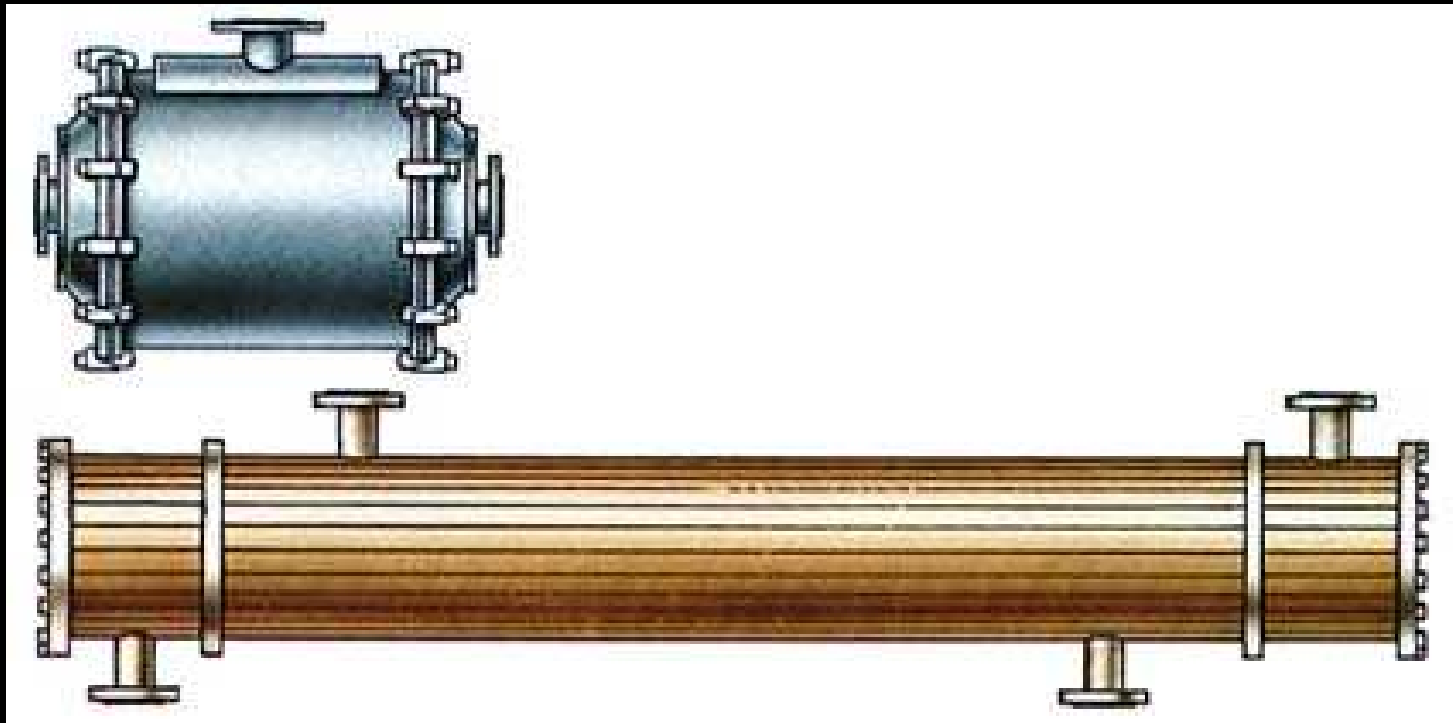
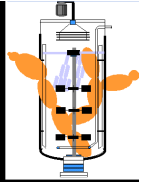

STERILIZATION

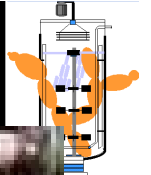

STERILIZATION

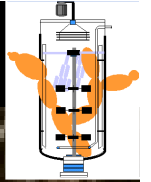

STERILIZATION

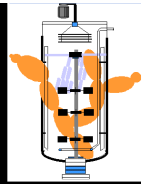

CONTINUOUS MEDIUM STERILIZATION PROCESS OUTLINE

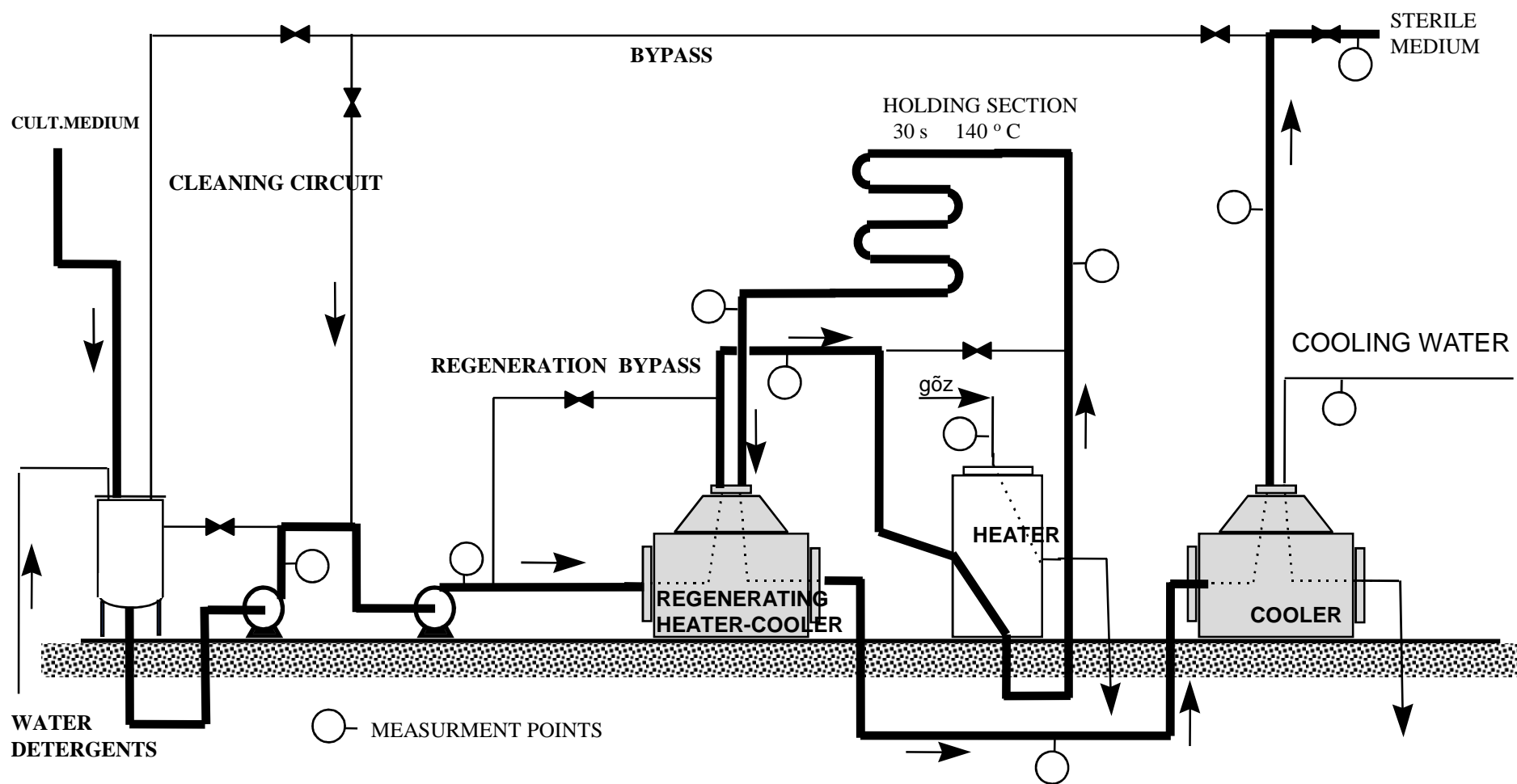

STERILIZATION

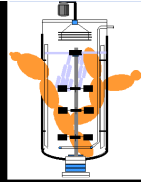

Continuous sterilizer (design) calculation

For holding section:

$$\ln \frac{N_0}{N_v} = k\Delta t = k \frac{L}{\frac{w}{q}}$$

L – length of holding section tube (m)

w – volumetric rate (m³/min)

q – tube cross sectional area (m²)

BUT!!!

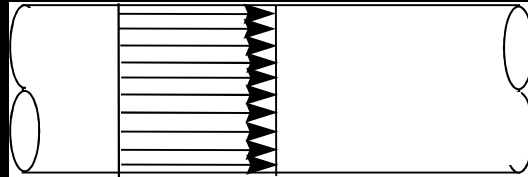

plug flow

$$\bar{u} = u_{\max}$$

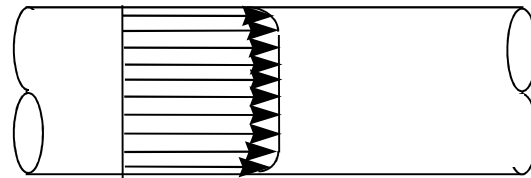

Turbulent stream

$$\bar{u} = 0,82 * u_{\max}$$

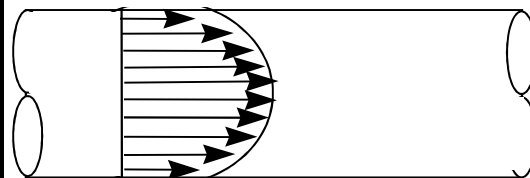

Laminar stream

$$\bar{u} = 0,5 * u_{\max}$$

STERILIZATION

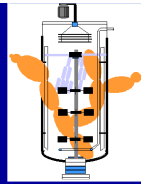

HOT POINTS

BOTTOM DRIVE

ELEKTRODES

MECHANICAL SEAL

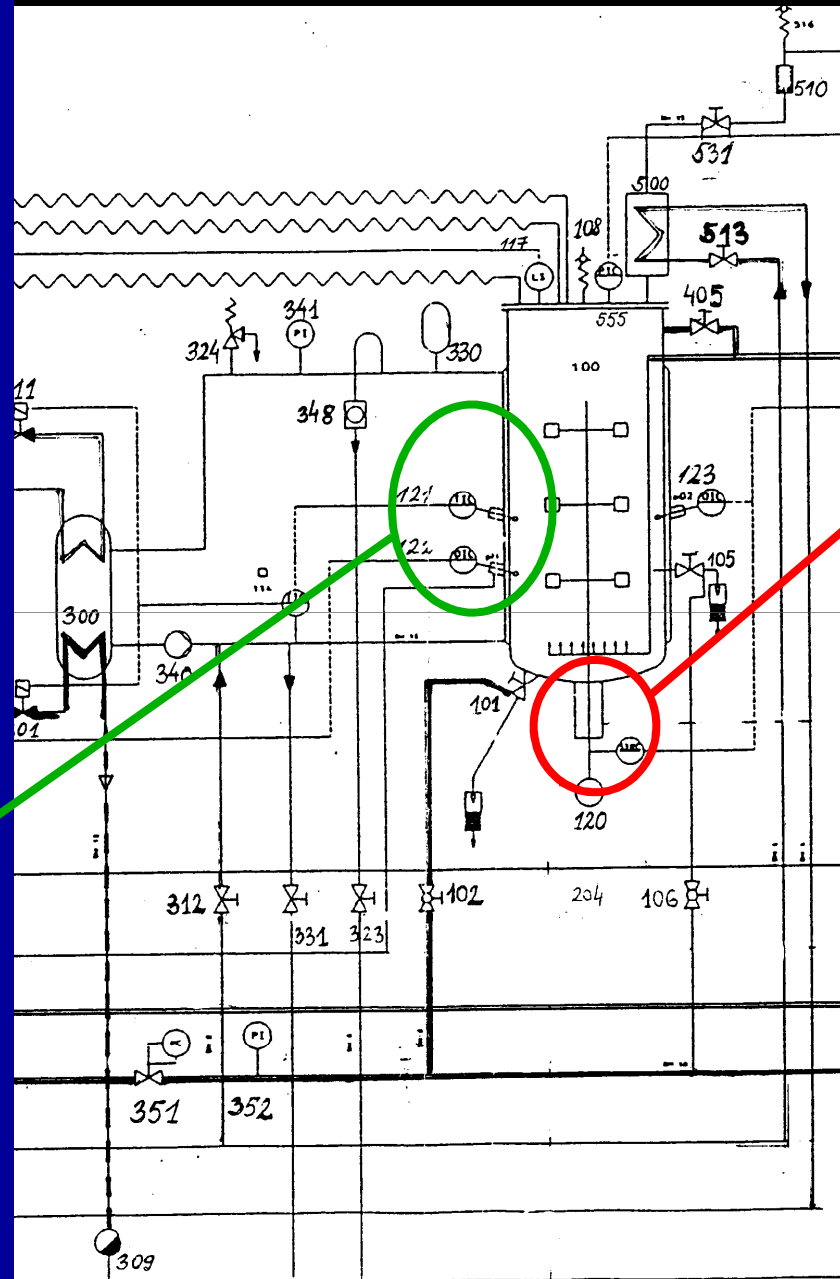

STERILEZÉS

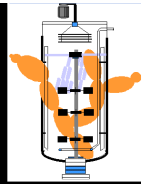

HOT POINTS

TOP DRIVE

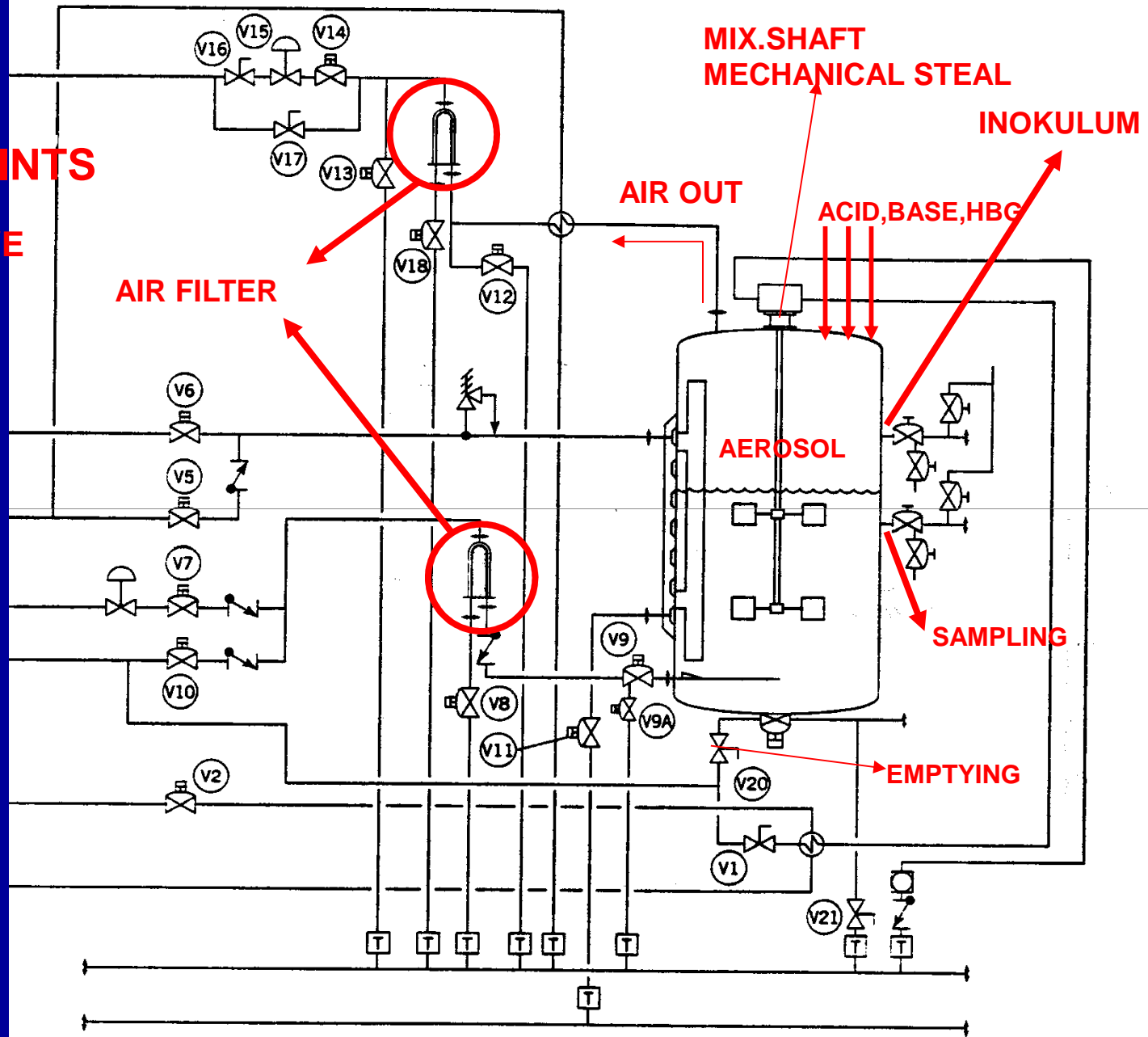

STERILIZATION

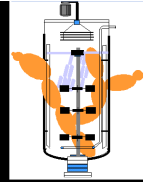

MIXING SHAFT
AIR IN, OUT
INGREDIENTS:
PIPES
VALVES
INOKULUM LINE
SENSORS
PUMPS

DOWN-STREAM: STERILE
NONSTERILE

STERILIZATION

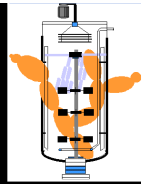

DOUBLE MECHANICAL SEAL

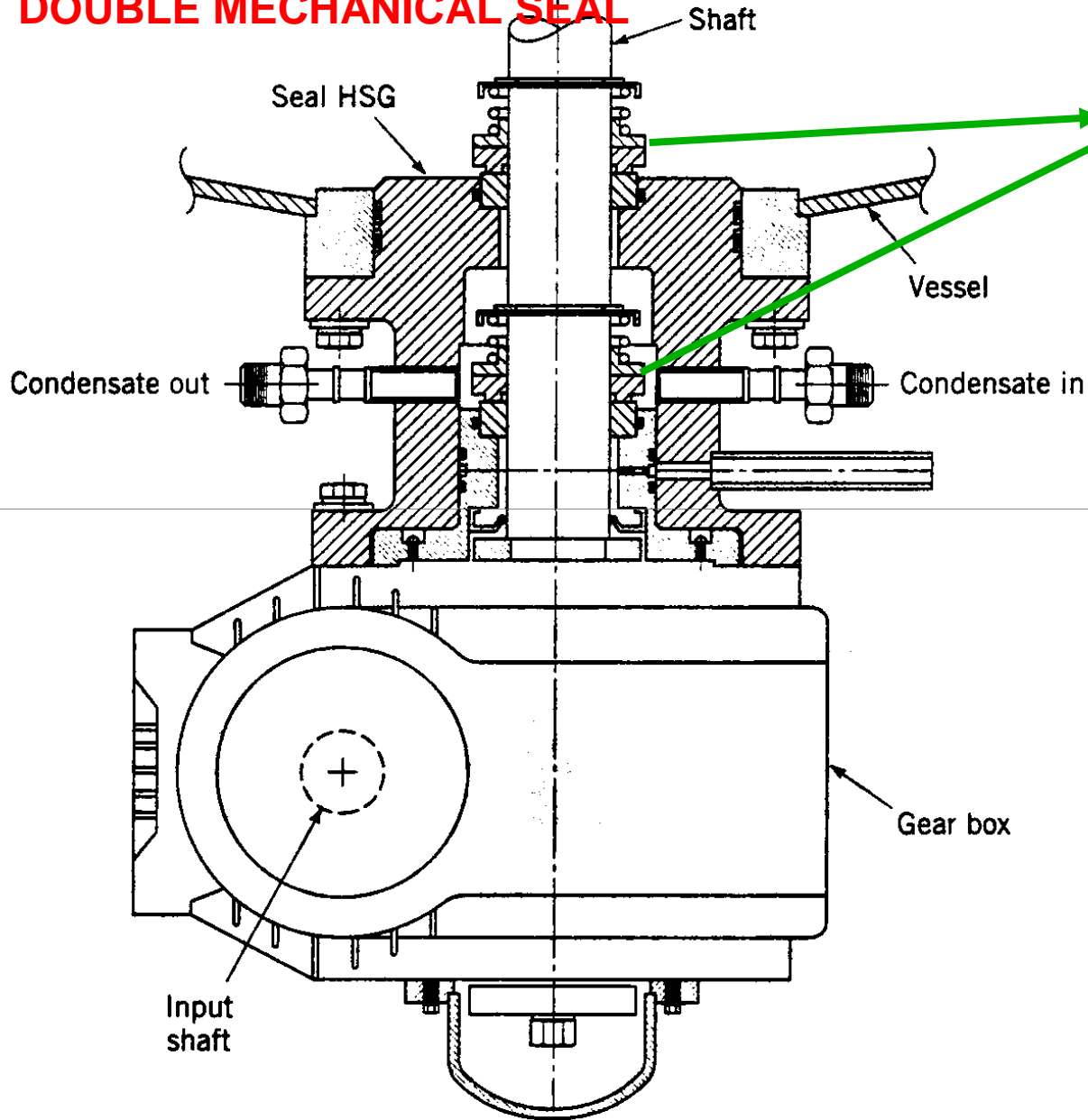

SLIPPING SURFACE

STERILE WATER –
LUBRICATION

STERILIZATION

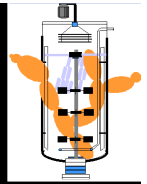

STERILE INOCULATION

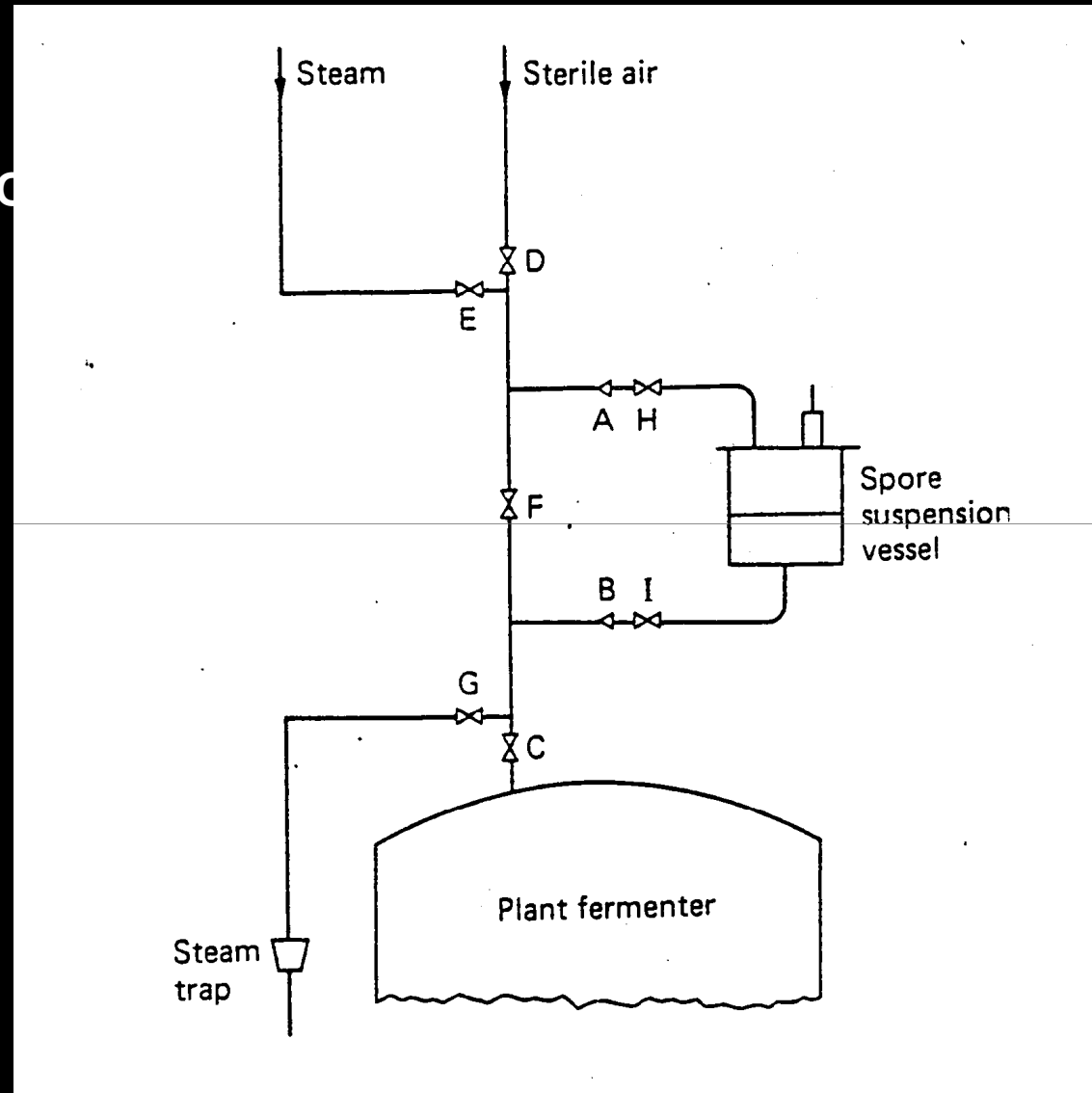

STERILIZATION

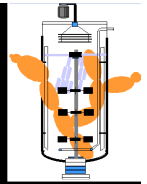

STERILE INOCULATION 2

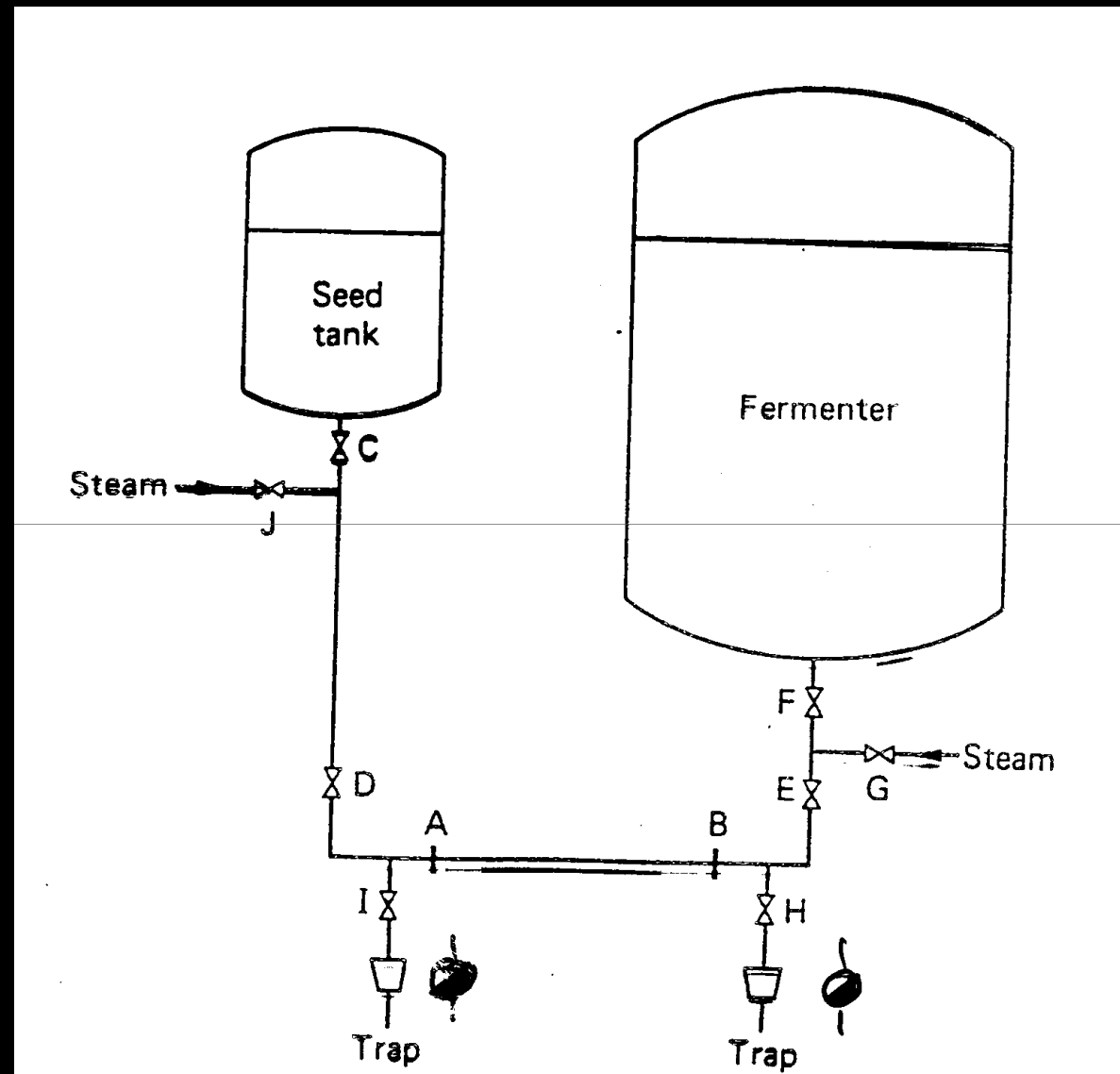

STERILIZATION

THERMODYNAMIC STEAM TRAP

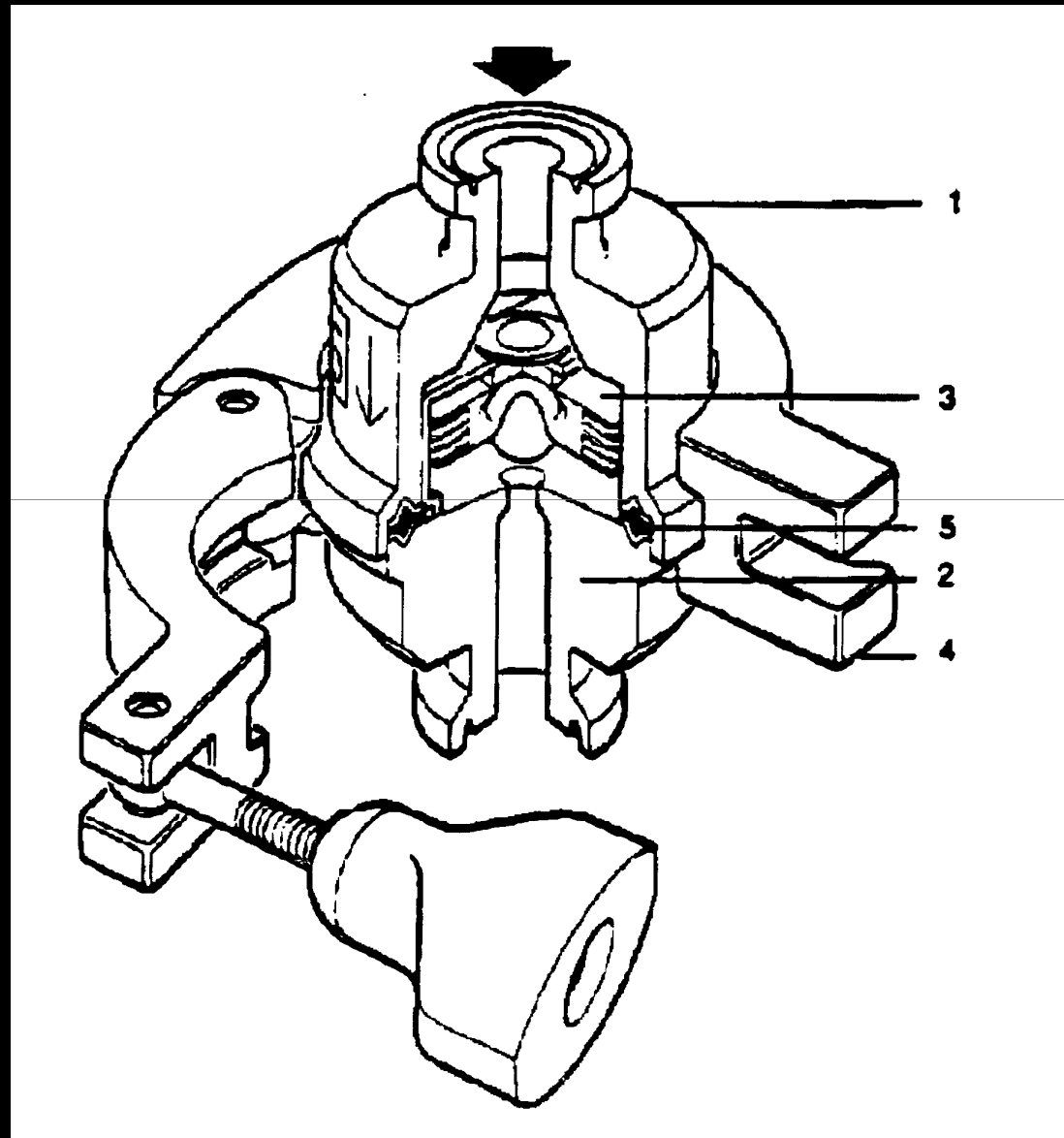
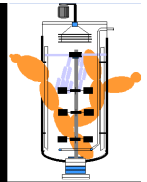

STERILIZATION

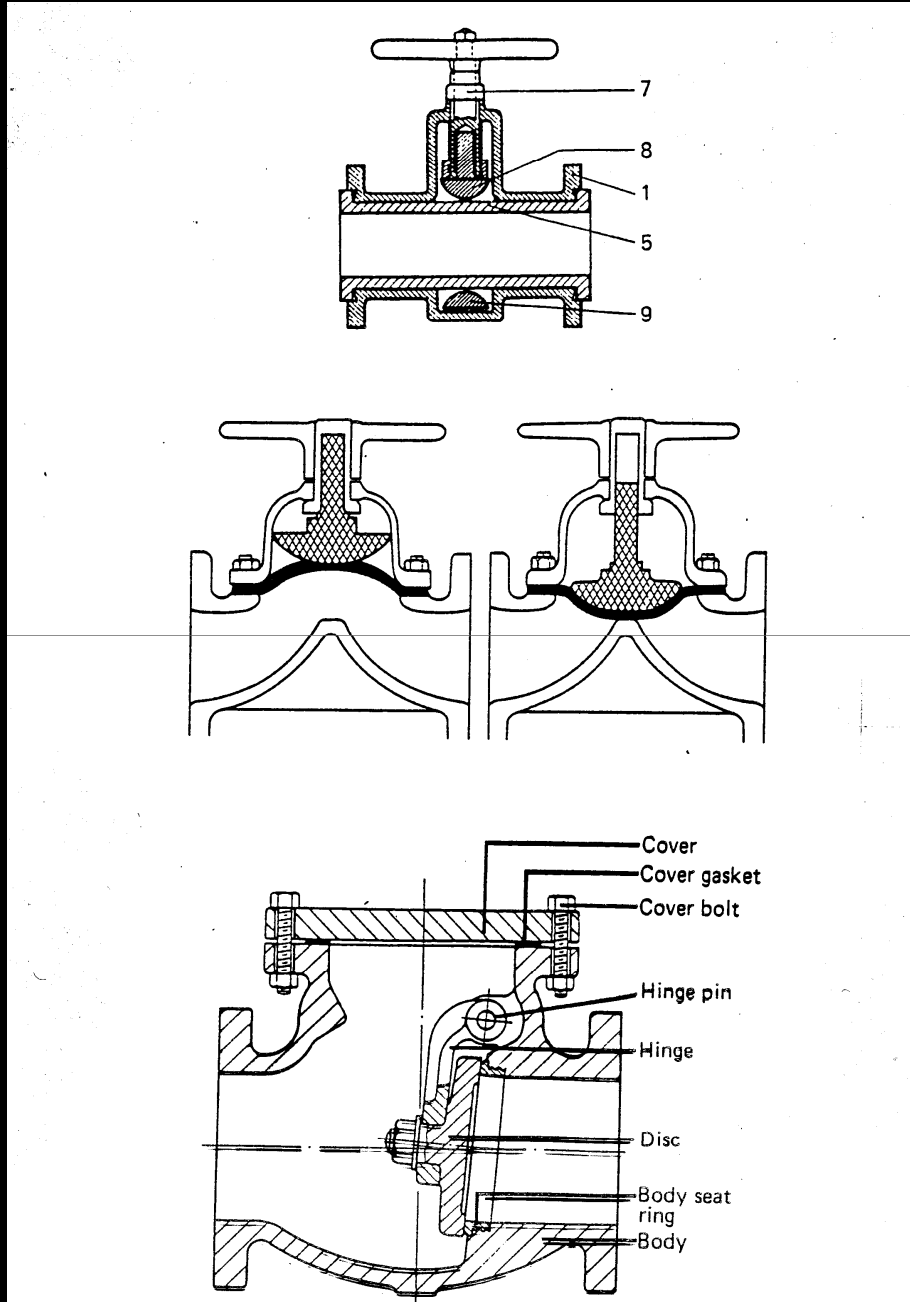
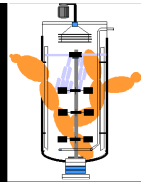

MEMBRANE VALVES

VISSZACSPÓSZELEP

STERILIZATION

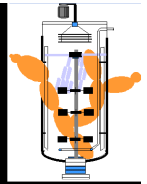

AIR FILTRATION

Absolute filter

PALL

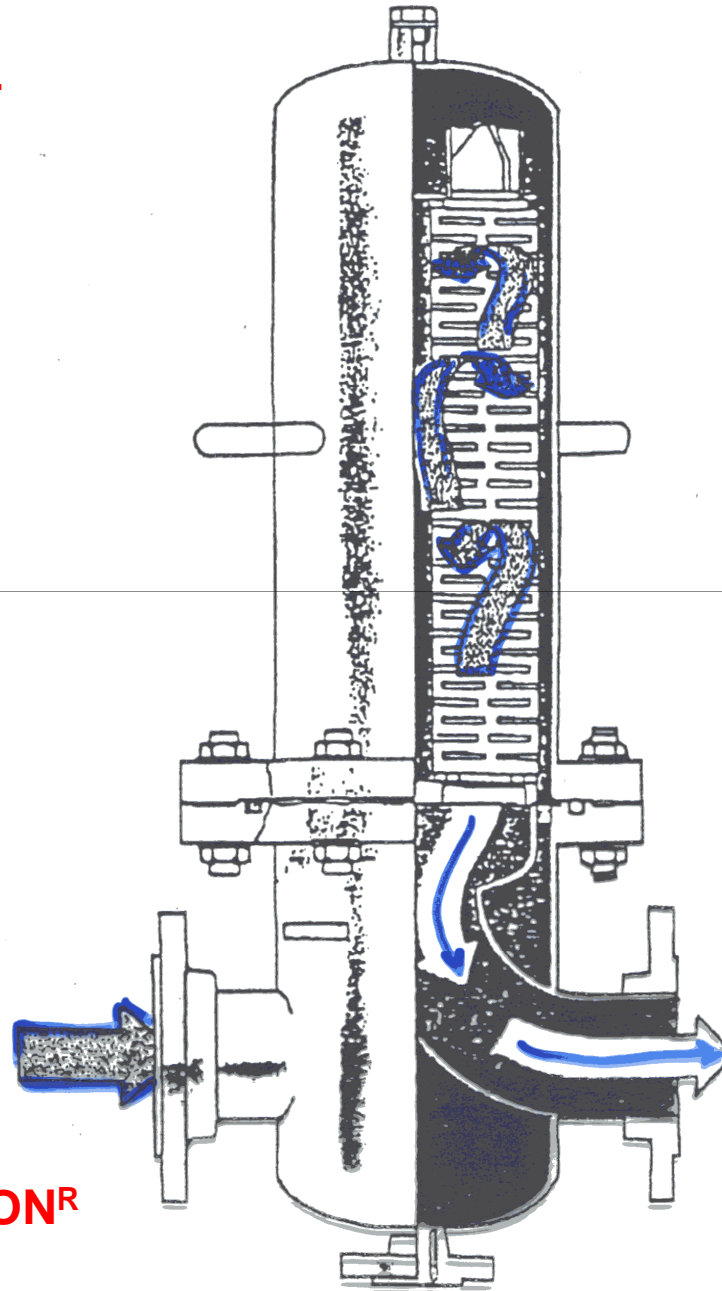

EMFLON^R

STERILIZATION

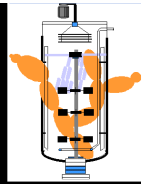

AIR FILTRATION

DEPTH FILTER

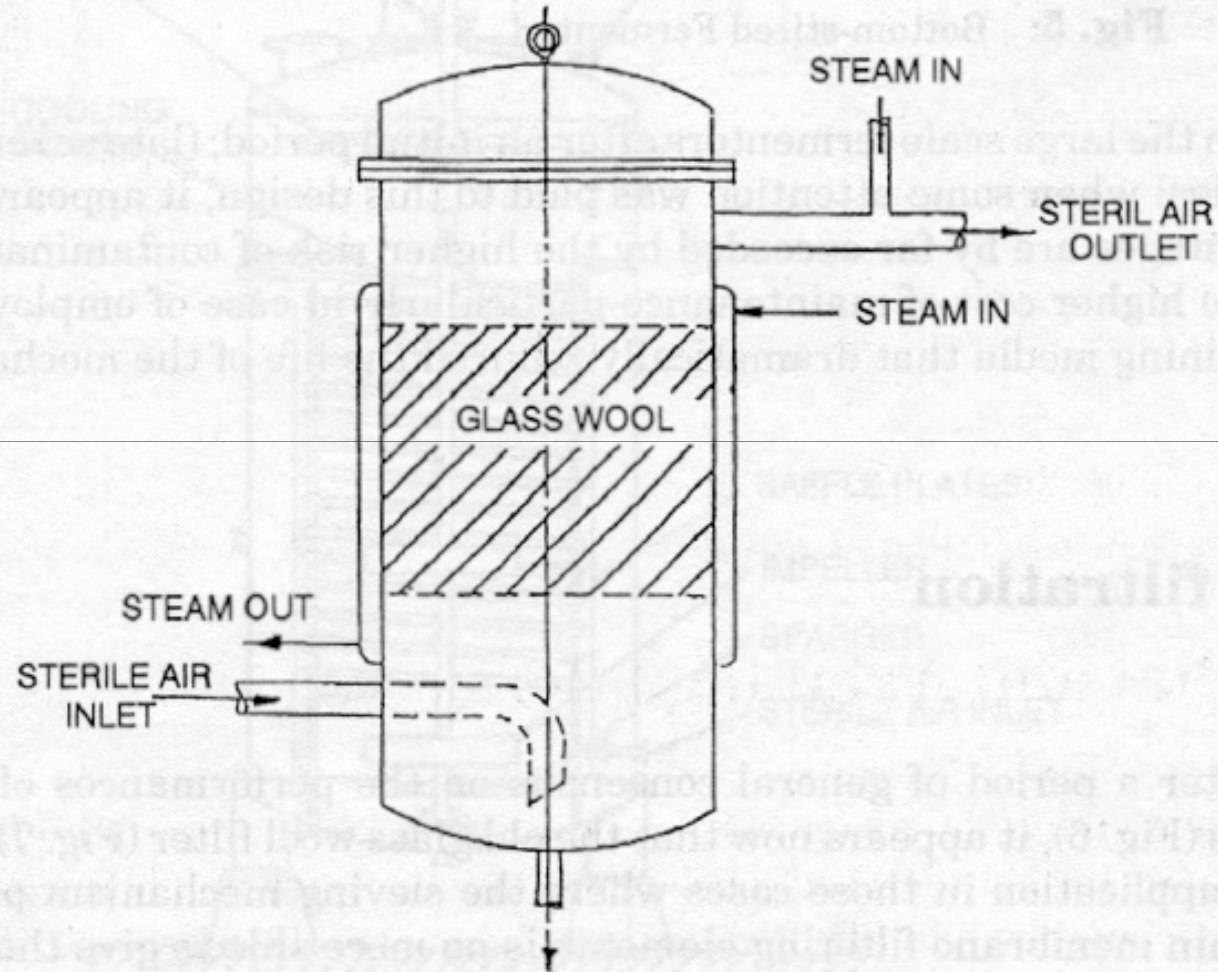

Fig. 7: Depth filter.

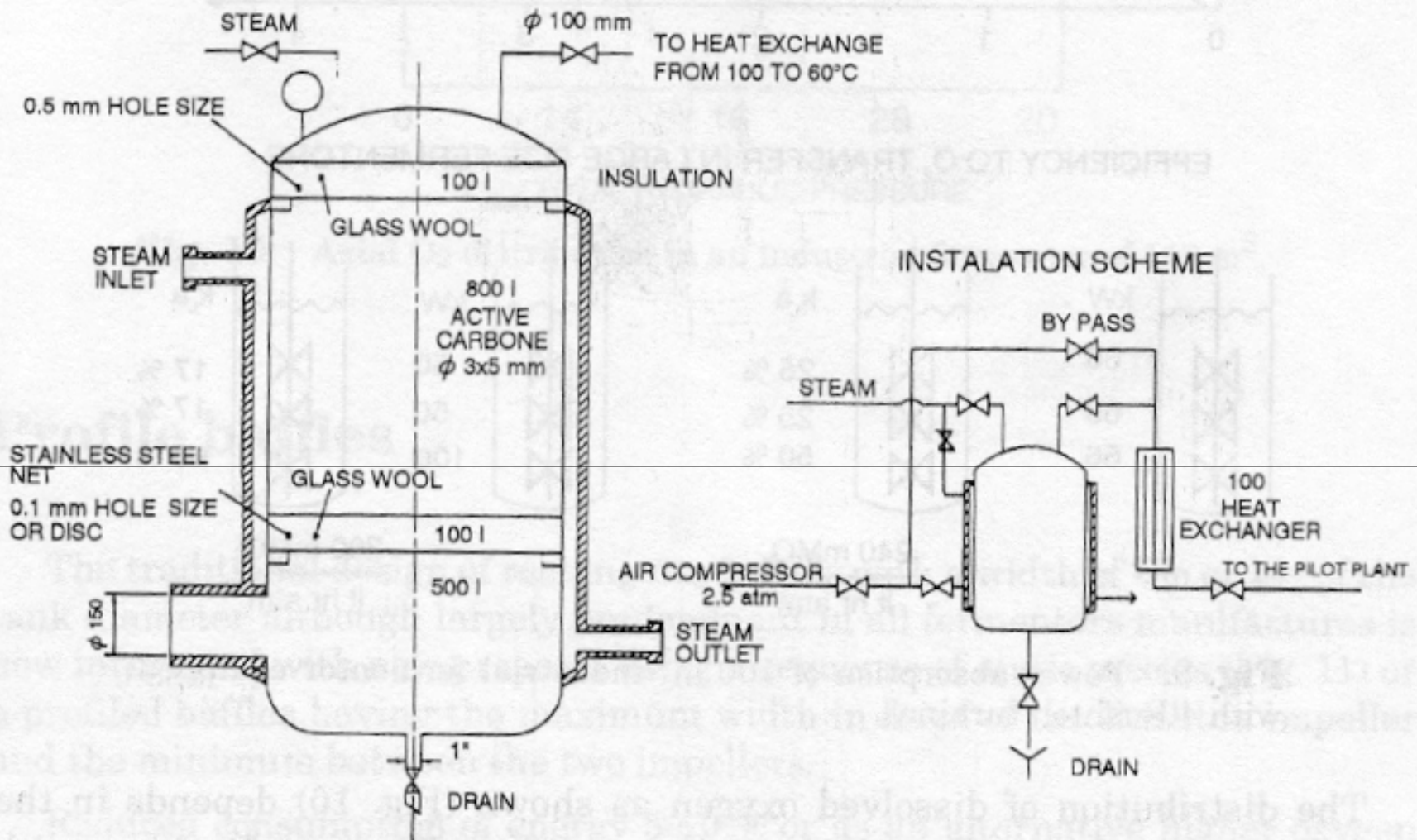
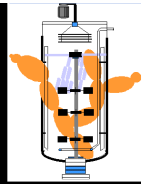

Fig. 8: Antiphage system.

STERILIZATION



CIP (CLEANING IN PLACE)

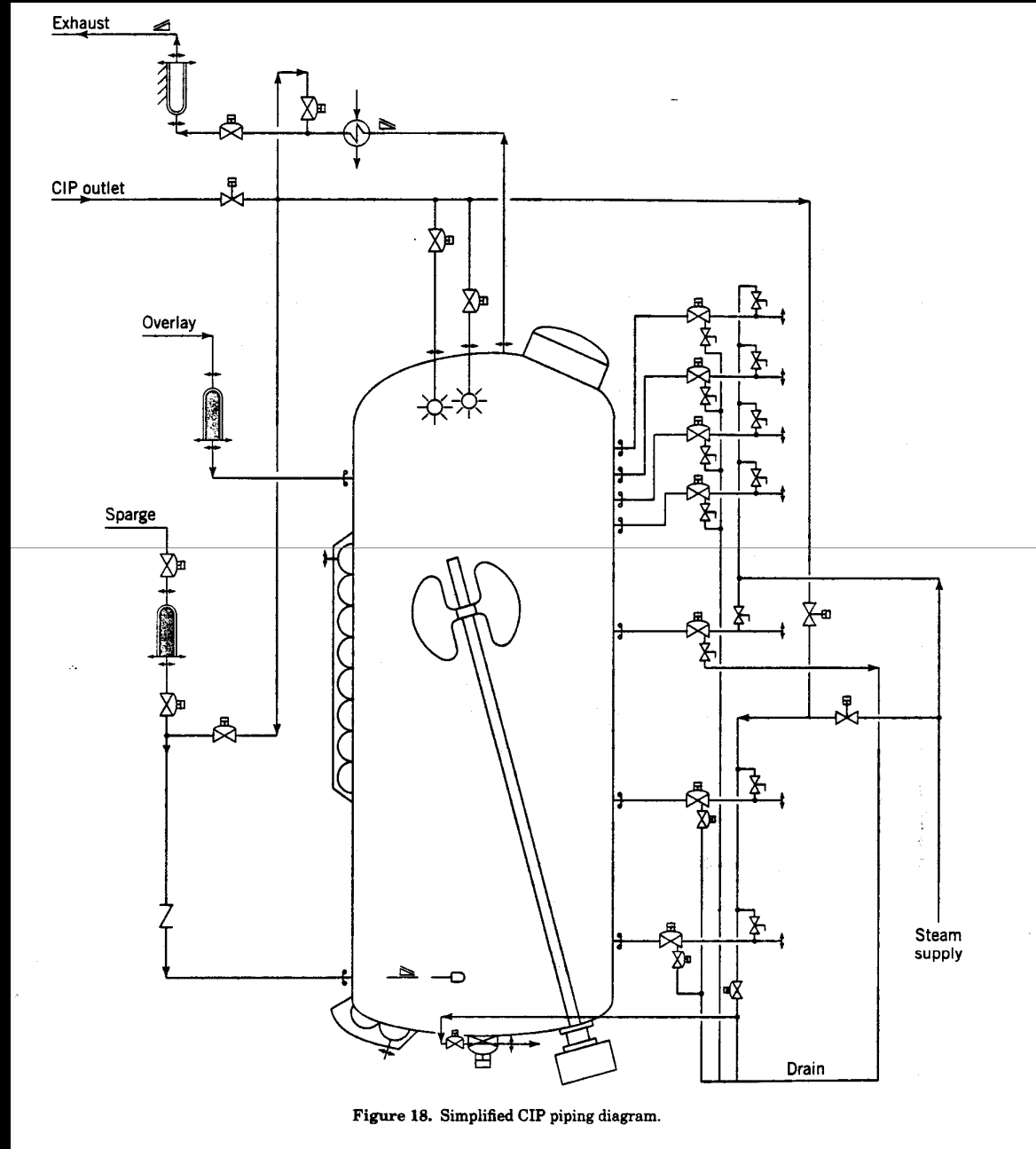

Figure 18. Simplified CIP piping diagram.